

WR (255) SERIES MOTOR

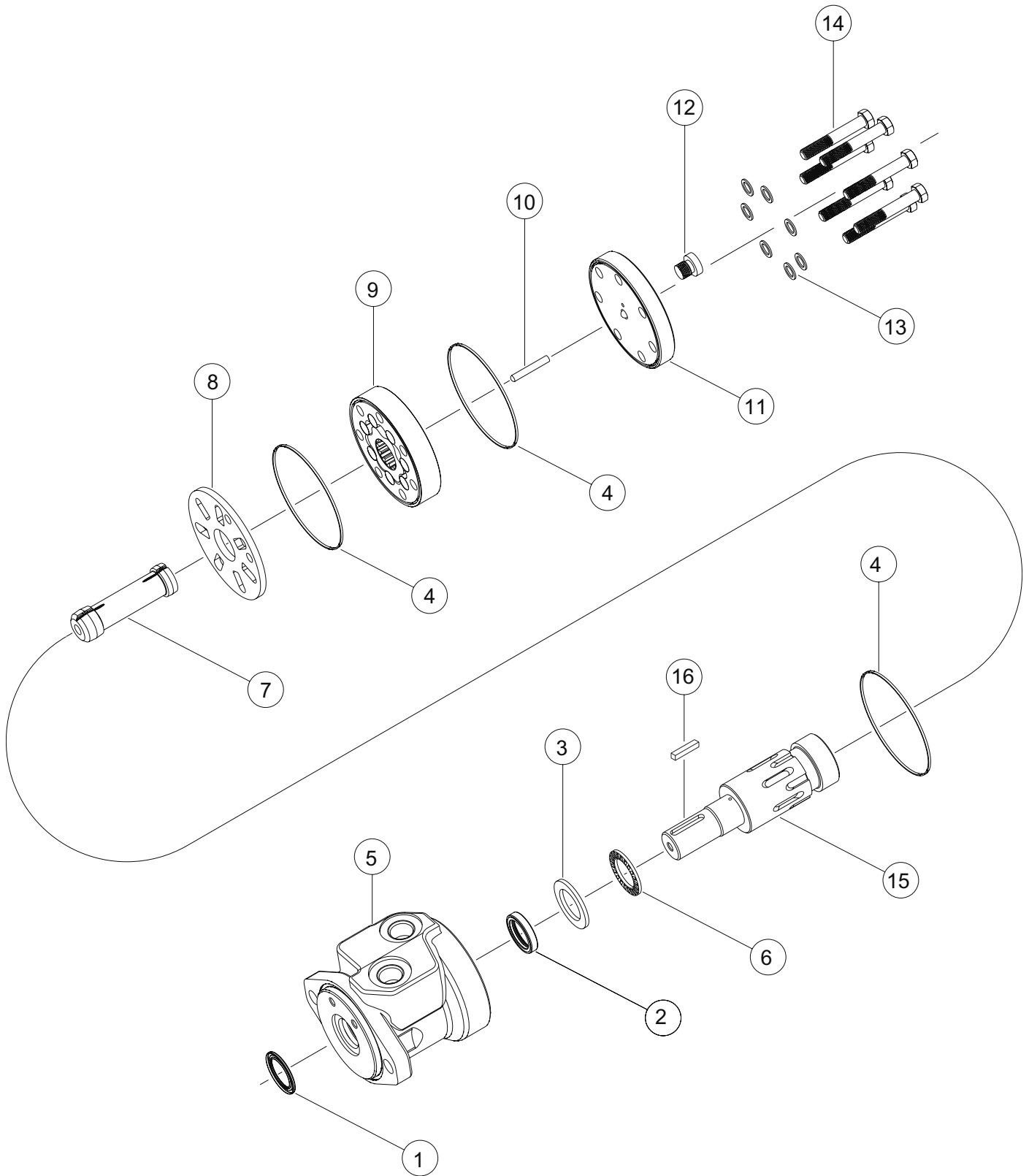

WR (255) SERIES MOTOR COMPONENTS

SEAL KIT 25522001

DESCRIPTION	EXP VIEW ITEM #	KIT
DUST SEAL	1	ITEMS #1-4 INCLUDED IN SEAL KIT: 25522001
SHAFT SEAL	2	
THRUST WASHER	3	
BODY SEALS (3)	4	
		25522001EG - SEAL KIT INCLUDES ITEM #1-4 SHAFT SEAL IS VITON

MISCELLANEOUS KITS

DESCRIPTION	EXPLODED VIEW ITEM #	KIT
THRUST BEARING	6	255018011
WEAR PLATE	8	255012001
ENDCOVER WITH BSP.F DRAIN	11	255016004
ENDCOVER WITH SAE DRAIN	11	255016005
SAE STEEL PLUG	12	500018186
BSP.F STEEL PLUG	12	300018084
BOLT WASHER SET	13	255018701
1000 PSI RELIEF VALVE	NOT SHOWN	500018228
2000 PSI RELIEF VALVE	NOT SHOWN	500018231
3/4-28 SLOTTED NUT	NOT SHOWN	200229300
3/4-28 LOCK NUT	NOT SHOWN	200018077

ROTORS, DRIVE LINKS AND SPACERS, AND BOLTS

WHEN CHANGING MOTOR DISPLACEMENTS, A MATCHING DRIVE LINK KIT, DRIVE LINK PIN KIT, AND BOLT SET KIT MUST ALSO BE ORDERED.

EXPLODED VIEW ITEM #	9	9	7	10	14
DISPLACEMENT	STANDARD ROTOR KIT	FREETURN ROTOR KIT	DRIVE LINK KIT	DRIVE LINK PIN KIT	BOLT SET KIT
040	255027003	---	200014002	200224003	255018101
060	255037003	---	200014002	200224008	255018102
070	255047003	---	200014001	200224005	255018102
090	255057003	---	200014001	200224006	255018103
100	255097003	---	200014001	200224008	255018103
115	255077003	---	200014003	200224008	255018104
130	255087003	---	200014003	200224010	255018104
160	255107003	---	200014003	200224012	255018105
200	255127003	---	200014003	200224014	255018106
240	255147003	---	200014003	200224018	255018107
320	255207003	---	200014003	200224024	255018108
400	255247003	---	200014003	255018019	255018109

HOUSING KITS

(EXPLODED VIEW ITEM #5)

BECAUSE THE HOUSING AND SHAFT ARE MATCH GROUND AS A SET TO EXTREMELY TIGHT TOLERANCES AT THE FACTORY, WHITE DRIVE PRODUCTS DOES NOT RECOMMEND THAT INDIVIDUAL HOUSINGS OR SHAFTS BE ORDERED TO REPAIR A MOTOR. IT IS RECOMMENDED THAT A MATCHED SET BE ORDERED. TO ORDER A MATCHED HOUSING/SHAFT KIT, PLEASE CONTACT A WHITE DRIVE PRODUCTS CUSTOMER SERVICE REPRESENTATIVE

DESCRIPTION	HOUSING KIT	DESCRIPTION	HOUSING KIT
#A63 - 2-HOLE OFFSET MANIFOLD 1/2" BSP.F (TP)	255013101	#A33 - 4-HOLE OFFSET MANIFOLD 1/2" BSP.F	255013127
#A62 - 2-HOLE MANIFOLD 1/2" BSP.F (TP)	255013102	#F33 - 4-HOLE OFFSET MANIFOLD 1/2" BSP.F	255013116
#A62 - 2-HOLE MANIFOLD 1/2" BSP.F (TP) W/RELIEF	255013103	#F38 - 4-HOLE ALIGNED PORTS 1/2" BSP.F	255013117
#A13 - 2-HOLE OFFSET MANIFOLD 1/2" BSP.F	255013105	#F30 - 4-HOLE ALIGNED PORTS 1/2" NPT	255013118
#A12 - 2-HOLE OFFSET PORTS 1/2" BSP.F	255013106	#F37 - 4-HOLE MANIFOLD PORTS	255013119
#A1D - 2-HOLE OFFSET MANIFOLD 7/8" O-RING	255013107	#G37 - 4-HOLE MANIFOLD PORTS METRIC TAP	255013120
#A11 - 2-HOLE FRONT PORTS 7/8" O-RING	255013109	#F39 - 4-HOLE 7/8" O-RING PORTS W/RELIEF	255013121
#A10 - 2-HOLE FRONT PORTS 7/8" O-RING	255013110	#F31 - 4-HOLE ALIGNED PORTS 7/8" O-RING	255013122
#A17 - 2-HOLE MANIFOLD PORTS 1/2" DRILLED	255013111	#F3D - 4-HOLE OFFSET MANIFOLD 7/8" O-RING	255013123
#AC3 - 4-HOLE OFFSET MANIFOLD 1/2" BSP.F (TP)	255013112	#G38 - 4-HOLE ALIGNED 1/2" BSP.F METRIC TAP	255013126
#A3D - 4-HOLE OFFSET MANIFOLD 7/8" O-RING	255013113	#B11 - 2-HOLE ALIGNED PORTS 7/8" O-RING	255013124
#A31 - 4-HOLE FRONT PORTS 7/8" O-RING	255013114	#B18 - 2-HOLE ALIGNED PORTS 1/2" BSP.F	255013125
#A30 - 4-HOLE FRONT PORTS 1/2" NPT	255013115		

SHAFTS AND RELATED COMPONENTS KITS

SHAFT KITS COME WITH RELATED SHAFT COMPONENTS (i.e. keys, nuts, etc.) TO ORDER INDIVIDUAL KEYS, USE THE KEY KIT NUMBER. TO ORDER NUT KITS (FOR #13 SHAFT), SEE MISCELLANEOUS KITS LIST ABOVE.

EXPLODED VIEW ITEM #	15	16
DESCRIPTION	SHAFT KIT	KEY KIT
#05- 1" WITH .373 PINHOLE	255011004	---
#53- 1" WITH .406 PINHOLE	255011005	---
#10- 1" STRAIGHT (5/16-18 UN TAP)	255011001	255018200
#02- 6-B SPLINE (5/16-18 UN TAP)	255011008	---
#01- 13 TOOTH SPLINE	255011011	---
#12- 25MM STRAIGHT	255011006	255018201
#13- 1" TAPERED	255011013	255018203
#B1- 25MM STRAIGHT W/ WOODRUFF KEY	255011016	255018205
#04- 6-B SPLINE (M8x1.25 TAP)	255011009	---
#98- 1" STRAIGHT (3/8-16UNC-2B)	255011017	255018200
#66- 1" WITH 8MM PINHOLE	255011003	---
#15- 1" STRAIGHT SPEED SENSOR	255011014	255018200
#16- 25MM STRAIGHT SPEED SENSOR	255011015	255018201
#11- 1" STRAIGHT (M8x1.25 TAP)	255011002	255018200

HOUSING/SHAFT KITS

HOUSING/SHAFT KITS COME WITH ITEMS 5, 15, & 16

TO ORDER A MATCHED HOUSING/SHAFT KIT, PLEASE CONTACT A WHITE DRIVE PRODUCTS CUSTOMER SERVICE REPRESENTATIVE.